

FLOOR BOX

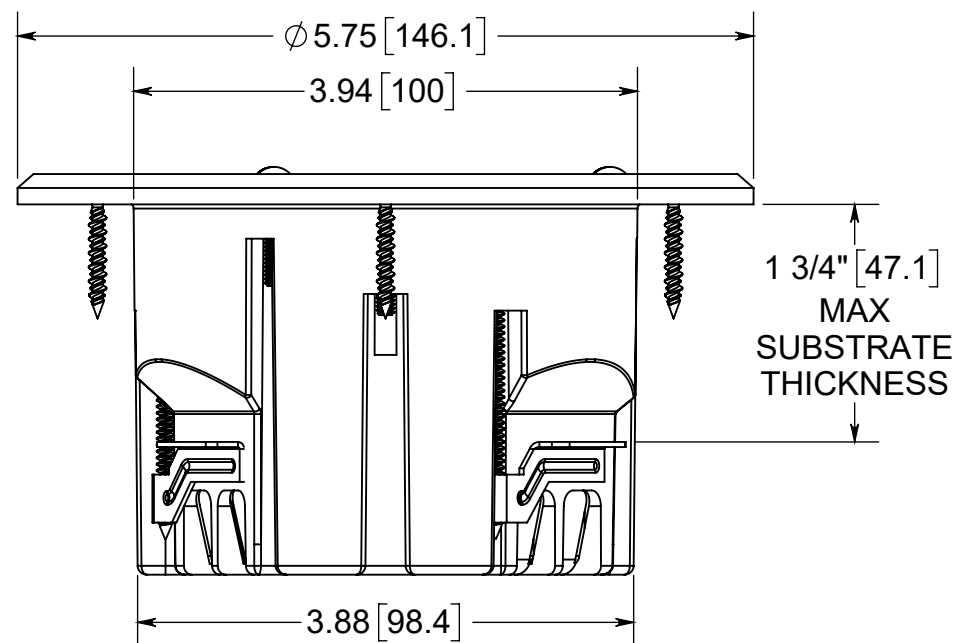
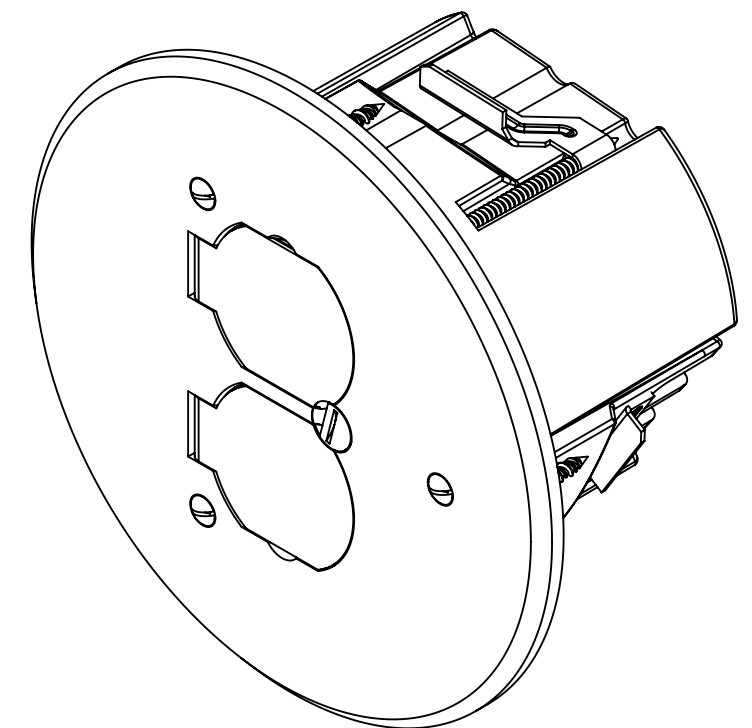
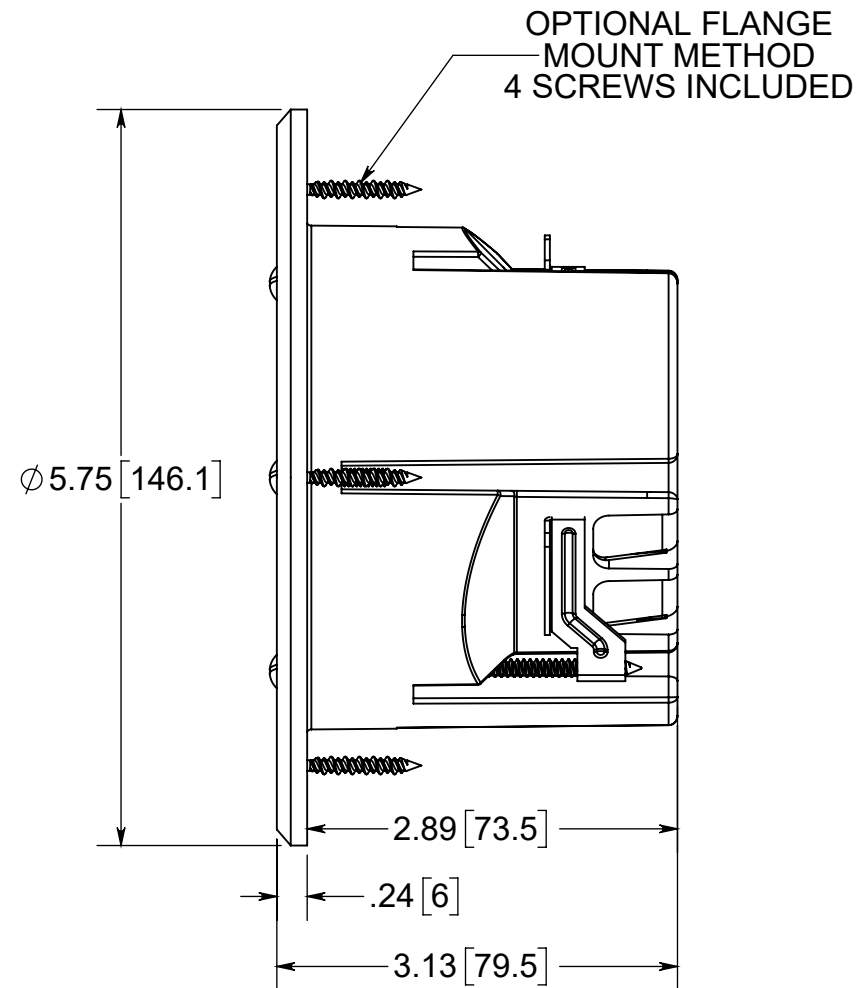
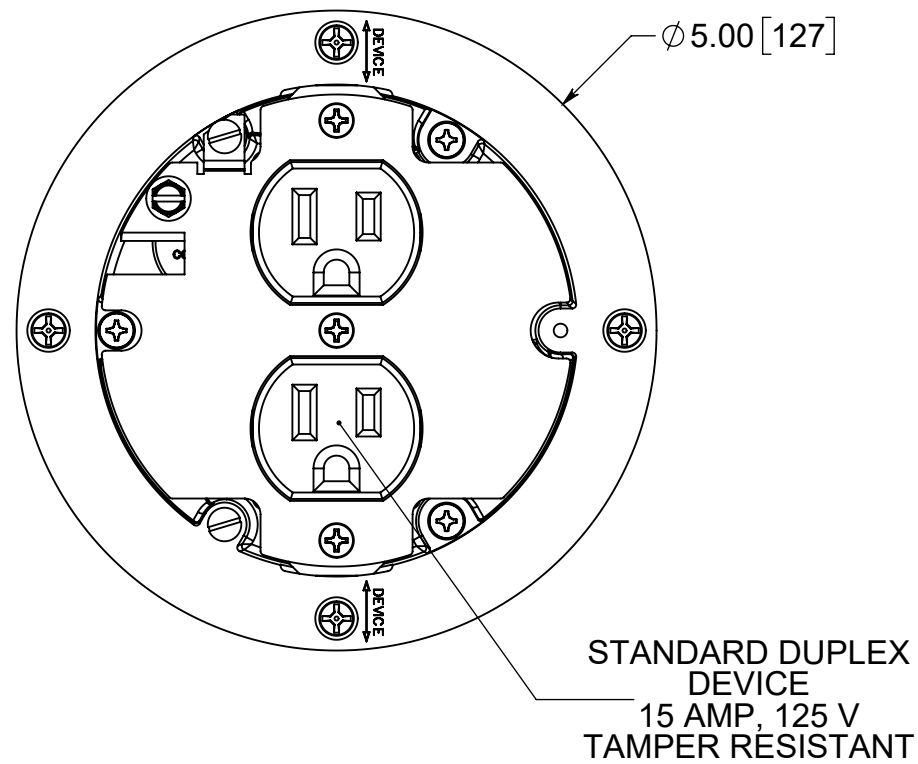

NOTES:

- 1.) BOX MATERIAL: POLYCARBONATE, COVER PLATE MATERIAL: DARK BRONZE PLATED BRASS, COVER PLATE MOUNTING SCREW MATERIAL: DARK BRONZE PLATED BRASS, DEVICE SCREW MATERIALS: ZINC PLATED STEEL, FLANGE MOUNTING SCREW MATERIAL: BLACK PHOSPHATE COATED STEEL WING MATERIAL: ZINC PLATED STEEL, GROUND PLATE MATERIAL: ZINC PLATED STEEL, GASKET MATERIALS: POLYURETHANE FOAM, O-RING MATERIAL: SILICONE
- 2.) UL LISTED, FLOOR BOX MEETS UL514C SCRUB WATER EXCLUSION TEST

WARNING:

This product can expose you to chemicals including lead, which is known to the State of California to cause cancer and birth defects or other reproductive harm. For more information go to www.P65Warnings.ca.gov.



ALLIED MOULDED PRODUCTS
BRYAN, OHIO

The Original Fiber Glass Outlet Box

PRODUCT SERIES

ROUND FLOOR BOX

Part No.

FB-7DB

CONFIDENTIAL

THIS MATERIAL IS OWNED BY THE ALLIED MOULDED PRODUCTS COMPANY, IS DISCLOSED IN CONFIDENCE, AND IS NOT TO BE REPRODUCED OR DISTRIBUTED WITHOUT PRIOR WRITTEN PERMISSION FROM ALLIED MOULDED PRODUCTS.